

New

Visually Detectable and Metal Detectable components

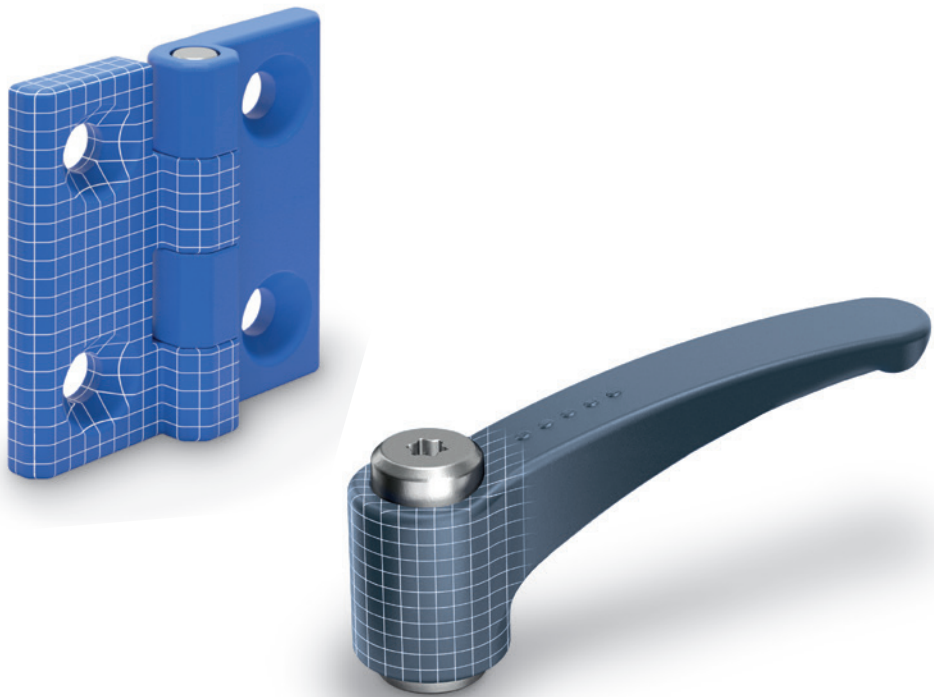

DESIGNED
FOR ENGINEERING



Increase the level of safety in your production lines

High cleanability, corrosion resistance, prevention from contaminants, operator safety and efficiency in functionality do not allow any compromise in the food and pharmaceutical sectors where reliable plants are essential.

Food and drugs are mainly produced industrially. Goods and preparations pass through various process stages on complex production lines. Any defects in these systems may cause accidental product contamination with serious consequences for the health of consumers if such defects are not detected.

Always attentive to the demands of the machinery and equipment industry, ELESAGANTER presents two new lines of standard components to meet the strict product safety requirements at all stages of a process, from preparation to final product packaging, in the name of contaminants detection.

VISUALLY DETECTABLE COMPONENTS



VTT-SST-VD

Solid knobs

Visually Detectable technopolymer, easy cleaning



page 6

ERZ-SST-VD

Adjustable handles

Visually Detectable technopolymer, stainless steel clamping element



page 7

M.643-SST-VD

Bridge handles

Visually Detectable technopolymer



page 8

EKK-SST-VD

Knurled grip knobs

Visually Detectable technopolymer



page 9

I.780-VD

Cylindrical handle

Visually Detectable technopolymer



page 9

CFM-VD

Hinges

Visually Detectable technopolymer



page 10

METAL DETECTABLE COMPONENTS



VTT-SST-MD

Solid knobs

Metal Detectable technopolymer, easy cleaning



page 11

ERZ-SST-MD

Adjustable handles

Metal Detectable technopolymer, stainless steel clamping element



page 12

M.643-SST-MD

Bridge handles

Metal Detectable technopolymer



page 13

EKK-SST-MD

Knurled grip knobs

Metal Detectable technopolymer



page 14

I.780-MD

Cylindrical handle

Metal Detectable technopolymer



page 14

CFM-MD

Hinges

Metal Detectable technopolymer



page 15

VISUALLY DETECTABLE



Standard components with AISI 304 stainless steel inserts, made of technopolymer, "Signal blue" RAL 5005, material suitable for contact with food (FDA CFR.21 and EU 10/2011), easily detectable and recognisable to the human eye thanks to the specificity and uniqueness of the colour, naturally absent in the environment in which these components are applied.

These characteristics contribute to increasing the levels of safety in food production processes in full compliance with international regulations.

The compliance with FDA regulations allows in addition a high level of prevention against the risk of contamination of the food.

- Machines for the food industry
- Pharmaceutical equipment

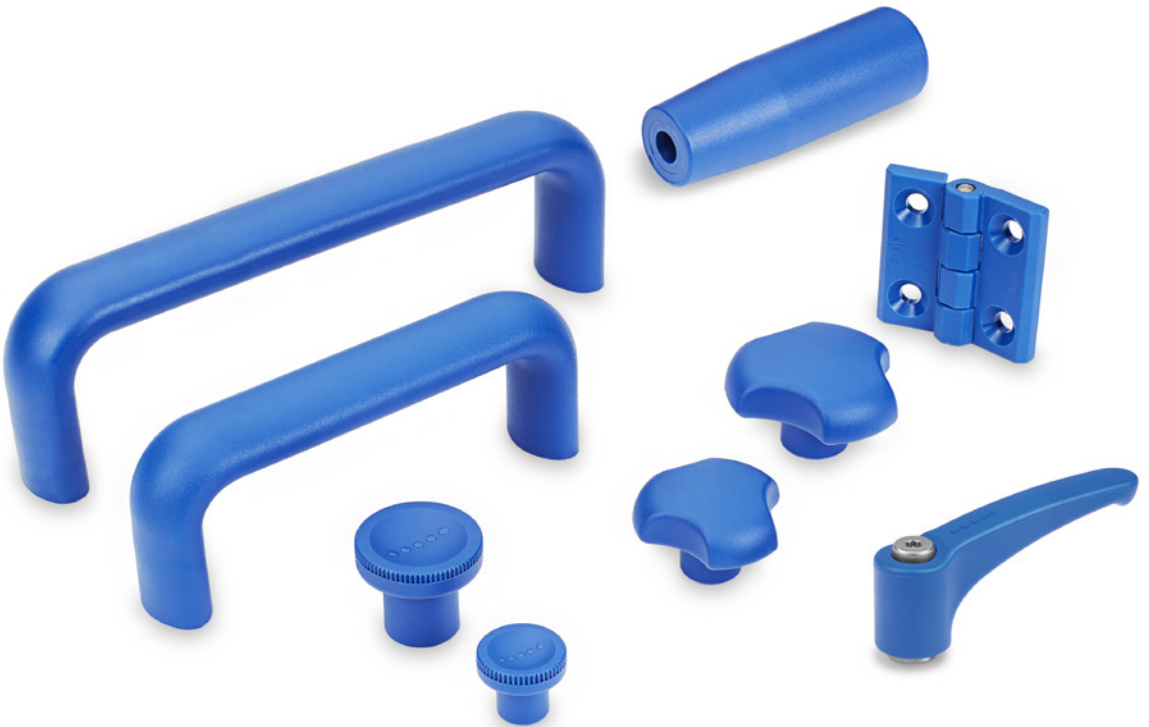

METAL DETECTABLE



Standard components with AISI 304 stainless steel inserts, made of technopolymer, "Green-blue" RAL 5001, material suitable for contact with food (FDA CFR.21 and EU 10/2011). The special additive contained in the plastic material, allows the detection of cubic particles of 5 mm by means of a metal detector.

Furthermore, the specificity and uniqueness of the blue colour, naturally absent in the environment in which these components are applied, allow also the visual detection of contaminant parts.

The compliance with FDA regulations allows in addition a high level of prevention against the risk of contamination of the food.

- Machines for the food industry
- Pharmaceutical equipment

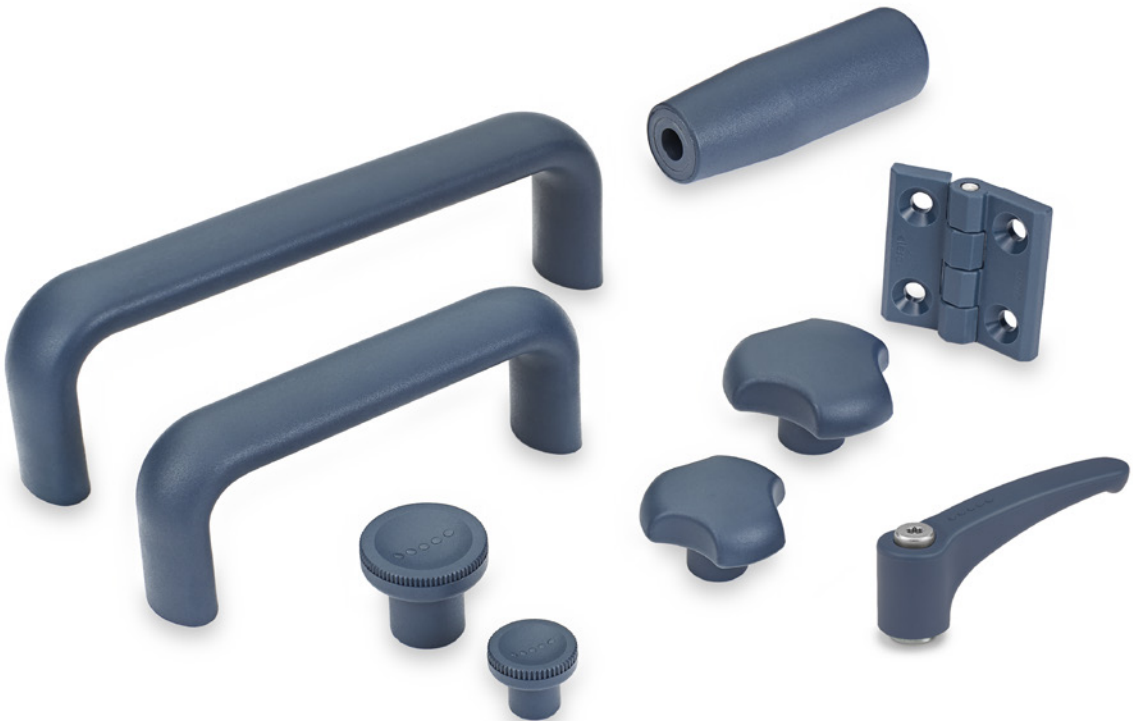

Solid knobs

Visually Detectable technopolymer, easy cleaning

MATERIAL

Glass-fibre reinforced polyamide based (PA) technopolymer, RAL 5005 blue colour, matte finish.
Produced from FDA compliant raw material (FDA CFR.21 and EU 10/2011).

STANDARD EXECUTIONS

- **VTT-SST-VD**: AISI 304 stainless steel boss, threaded blind hole.
- **VTT-SST-p-VD**: AISI 304 stainless steel threaded stud, chamfered flat end according to UNI 947 : ISO 4753 (see Technical data).

FEATURES AND APPLICATIONS

The RAL 5005 blue colour is easily visible in case of accidental food contamination.

Particularly suitable for applications in the food and pharmaceutical industries.

The three-lobe shape with large recesses ensures an effective grip even with work gloves.

The design without rear cavities, generally adopted for reducing thickness, prevents unhealthy residues from depositing, ensuring easy cleaning. Particularly suitable for applications on machines and equipment whose parts must be frequently cleaned by using water jets or steam.



ELESA Original design

VTT-SST-VD

VTT-SST-p-VD

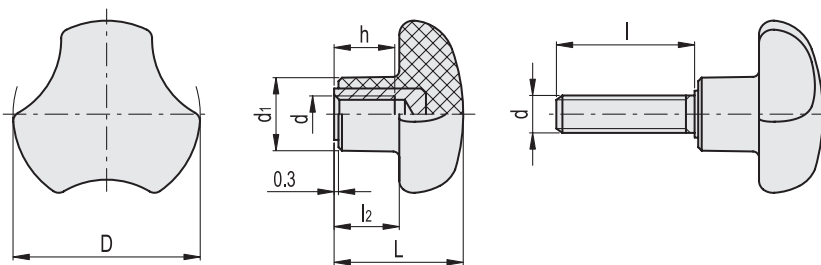

VTT-SST-VD

STAINLESS STEEL

Code	Description	D	d6H	L	d1	l2	h	△△
190346	VTT.40-SST-M8-VD	40	M8	27	16	13.5	13	23
190476	VTT.50-SST-M10-VD	50	M10	30	19	15	17	36

VTT-SST-p-VD

STAINLESS STEEL

Code	Description	D	d6g	L	d1	l	l2	△△
190381	VTT.40-SST-p-M8x20-VD	40	M8	27	16	20	13.5	28
190383	VTT.40-SST-p-M8x30-VD	40	M8	27	16	30	13.5	30
190493	VTT.50-SST-p-M10x30-VD	50	M10	30	19	30	15	47
190495	VTT.50-SST-p-M10x40-VD	50	M10	30	19	40	15	52

Adjustable handles

Visually Detectable technopolymer, stainless steel clamping element

LEVER BODY

Glass-fibre reinforced polyamide based (PA) technopolymer, RAL 5005 blue colour, matte finish.
Produced from FDA compliant raw material (FDA CFR.21 and EU 10/2011).
Built-in zinc alloy toothed insert for coupling to the metal clamping element.

STANDARD EXECUTIONS

- **ERZ-SST-VD**: AISI 303 stainless steel clamping element with threaded hole and retaining screw. AISI 302 stainless steel return spring.
 - **ERZ-SST-p-VD**: AISI 303 stainless steel clamping element with threaded stud and retaining screw. AISI 302 stainless steel return spring.
- Retaining screw with six-lobed socket to fit TORX®.

FEATURES AND APPLICATIONS

The RAL 5005 blue colour is easily visible in case of accidental food contamination.
Particularly suitable for applications in the food and pharmaceutical industries.
Particularly suitable when the lever turning angle is limited owing to lack of space.
The metal teeth of the built-in zinc alloy insert allow the assembly of clamping elements completely made out of metal, which can be easily modified by machining in case of special assembly requirements.



ERGOSTYLE®

INSTRUCTIONS OF USE

For clamping, lift the lever to disengage the clamping device teeth and bring it back to start position. By releasing the lever, the return spring automatically engages the teeth.
If the lever cannot make a 360° rotation, the clamping element can be easily screwed by means of the six-lobed socket front head screw (after having disengaged the lever).

* Registered trademark by TEXTRON INC.

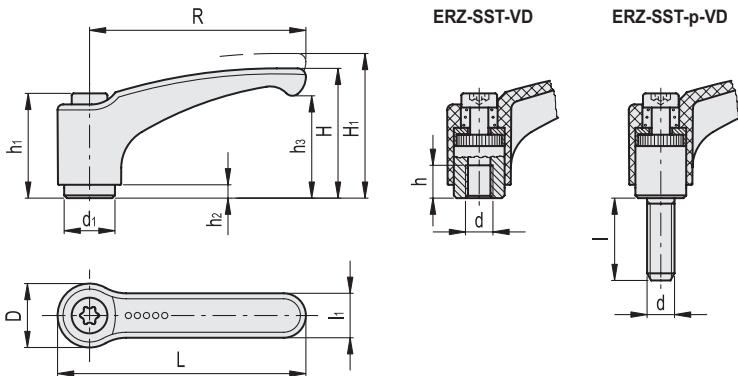

ERZ-SST-VD

STAINLESS STEEL

Code	Description	R	d	L	D	H	H1	h	h1	h2	h3	d1	l1	Teeth no.	⚖
193135	ERZ.63 SST-M6-VD	63	M6	73.5	19	38.5	42	10	31	3.5	30	13.5	13.5	24	36
193155	ERZ.78 SST-M8-VD	78	M8	90.5	23	45	50.5	14	36	3.5	35	16	16	26	61

ERZ-SST-p-VD

STAINLESS STEEL

Code	Description	R	d	L	D	H	H1	h1	h2	h3	d1	l	l1	Teeth no.	⚖
193429	ERZ.63 SST-p-M6x16-VD	63	M6	73.5	19	38.5	42	31	3.5	30	13.5	16	13.5	24	40
193433	ERZ.63 SST-p-M6x25-VD	63	M6	73.5	19	38.5	42	31	3.5	30	13.5	25	13.5	24	42
193673	ERZ.78 SST-p-M8x20-VD	78	M8	90.5	23	45	50.5	36	3.5	35	16	20	16	26	69
193679	ERZ.78 SST-p-M8x40-VD	78	M8	90.5	23	45	50.5	36	3.5	35	16	40	16	26	80

Bridge handles

Visually Detectable technopolymer

MATERIAL

Glass-fibre reinforced polyamide based (PA) technopolymer, RAL 5005 blue colour, matte finish.
Produced from FDA compliant raw material (FDA CFR.21 and EU 10/2011).

STANDARD EXECUTION

AISI 303 stainless steel bosses, threaded holes.

FEATURES AND APPLICATIONS

The RAL 5005 blue colour is easily visible in case of accidental food contamination.
Particularly suitable for applications in the food and pharmaceutical industries.

TECHNICAL DATA

Tensile stress and impact strength: F1, F2, L1 and L2 values reported in the table are the result of breaking tests carried out with the appropriate dynamometric equipment under the test conditions shown in the figure with ambient temperature.



ELESA Original design

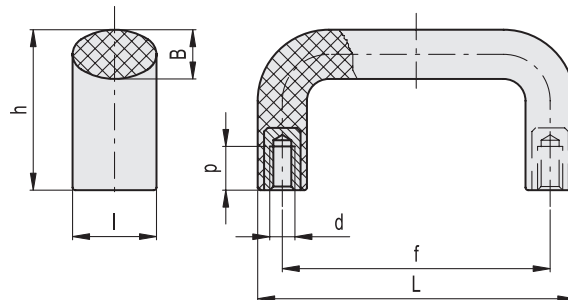
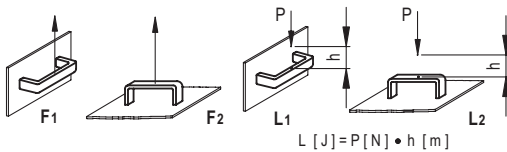

STAINLESS STEEL

Code	Description	L	f	d6H	h	B	l	p	F1 [N]	F2 [N]	L1 [J]	L2 [J]	⚖️
194113	M.643/140-117-SST-M8-VD	134	117±0.5	M8	49	15	25	13	3500	4500	8	12	67
194153	M.643/200-SST-M8-VD	196	179±1	M8	57	16	27	13	2500	3000	11	15	130

Knurled grip knobs

Visually Detectable technopolymer

MATERIAL

Glass-fibre reinforced polyamide based (PA) technopolymer, RAL 5005 blue colour, matte finish.
Produced from FDA compliant raw material (FDA CFR.21 and EU 10/2011).

STANDARD EXECUCION

AISI 303 stainless steel boss, threaded blind hole.

FEATURES AND APPLICATIONS

The RAL 5005 blue colour is easily visible in case of accidental food contamination.
Particularly suitable for applications in the food and pharmaceutical industries.



Cylindrical handle

Visually Detectable technopolymer

MATERIAL

Glass-fibre reinforced polyamide based (PA) technopolymer, RAL 5005 blue colour, matte finish.
Produced from FDA compliant raw material (FDA CFR.21 and EU 10/2011).

MOUNTING

Threaded blind hole.

FEATURES AND APPLICATIONS

The RAL 5005 blue colour is easily visible in case of accidental food contamination.
Particularly suitable for applications in the food and pharmaceutical industries.



ELESA Original design

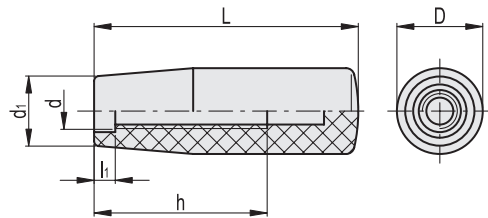
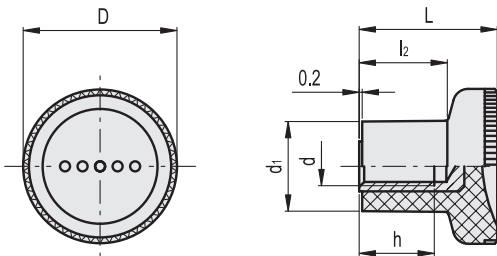

STAINLESS STEEL

Code	Description	D	L	d6H	d1	h	l2	△
194416	EKK.21-SST M5-VD	21	18	M5	12.5	10	10.5	7
194436	EKK.31-SST M8-VD	31	27	M8	18.5	15	17	20

Code	Description	D	L	d	d1	h	l1	△
194307	I.780/80-M10-VD	26.5	80	M10	21	55	7	45

Hinges

Visually Detectable technopolymer

MATERIAL

Glass-fibre reinforced polyamide based (PA) technopolymer, RAL 5005 blue colour, matte finish.
Produced from FDA compliant raw material (FDA CFR.21 and EU 10/2011).

ROTATING PIN

AISI 303 stainless steel.

STANDARD EXECUTION

Pass-through holes for countersunk head screws.

FEATURES AND APPLICATIONS

The RAL 5005 blue colour is easily visible in case of accidental food contamination.
Particularly suitable for applications in the food and pharmaceutical industries.

ROTATION ANGLE (APPROXIMATE VALUE)

Max 270° (-90° and +180° being 0° the condition where the two interconnected surfaces are on the same plane).
Do not exceed the rotation angle limit so as not to prejudice the hinge mechanical performance.
To choose the convenient type and the right number of hinges for your application, see the Guidelines.

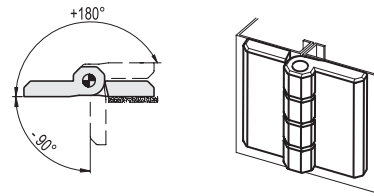

Resistance tests	AXIAL STRESS		RADIAL STRESS		90° ANGLED STRESS	
Description	Maximum working load Ea [N]	Load at breakage Ra [N]	Maximum working load Er [N]	Load at breakage Rr [N]	Maximum working load E90 [N]	Load at breakage R90 [N]
CFM.40 SH-5-VD	100	1600	200	1900	200	1200
CFM.50 SH-6-VD	100	2100	200	3100	200	2000

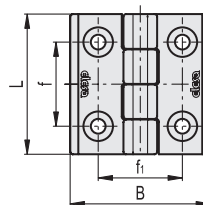
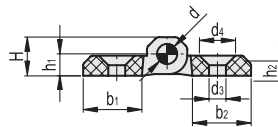

STAINLESS STEEL

Code	Description	L	B	f±0.25	f1±0.25	H	h1	h2	b1	b2	d	d3	d4	C# [Nm]	
199511	CFM.40-SH-5-VD	40	40	25	25	9	5.5	5	14	14	4	5.5	10.5	3	14
199611	CFM.50-SH-6-VD	50	50	30	30	11.5	6.5	6	18	18	6	6.5	12.5	5	30

Suggested tightening torque for assembly screws.

Solid knobs

Metal Detectable technopolymer, easy cleaning

MATERIAL

Glass-fibre reinforced polyamide based (PA) technopolymer, RAL 5001 blue colour, matte finish.

Produced from FDA compliant raw material (FDA CFR.21 and EU 10/2011). The special technopolymer contains additives detectable by means of metal detectors.

STANDARD EXECUTIONS

- **VTT-SST-MD**: AISI 304 stainless steel boss, threaded blind hole.
- **VTT-SST-p-MD**: AISI 304 stainless steel threaded stud, chamfered flat end according to UNI 947 : ISO 4753 (see Technical data).

FEATURES AND APPLICATIONS

The RAL 5001 blue colour is easily visible in case of accidental food contamination. Furthermore the material additives are metal detectable at a cubic particle size of 5mm per side.

In order to improve the detection, the metal detector calibration must take into account the food/substance type at risk of contamination considering the moisture contained in it.

Particularly suitable for applications in the food and pharmaceutical industries.

The three-lobe shape with large recesses ensures an effective grip even with work gloves.

The design without rear cavities, generally adopted for reducing thickness, prevents unhealthy residues from depositing, ensuring easy cleaning. Particularly suitable for applications on machines and equipment whose parts must be frequently cleaned by using water jets or steam.



ELESA Original design

VTT-SST-MD

VTT-SST-p-MD

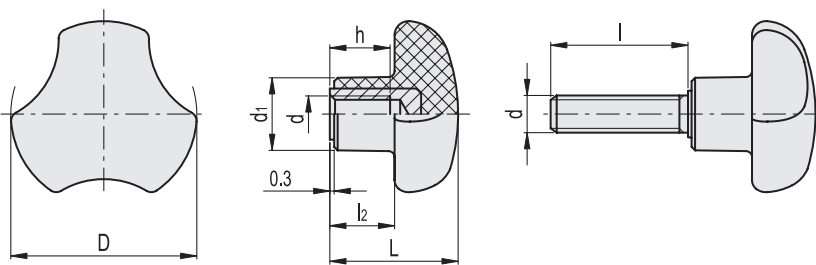

VTT-SST-MD

STAINLESS STEEL

Code	Description	D	d6H	L	d1	l2	h	△△
195346	VTT.40-SST-M8-MD	40	M8	27	16	13.5	13	23
195476	VTT.50-SST-M10-MD	50	M10	30	19	15	17	36

VTT-SST-p-MD

STAINLESS STEEL

Code	Description	D	d6g	L	d1	l	l2	△△
195381	VTT.40-SST-p-M8x20-MD	40	M8	27	16	20	13.5	28
195383	VTT.40-SST-p-M8x30-MD	40	M8	27	16	30	13.5	30
195493	VTT.50-SST-p-M10x30-MD	50	M10	30	19	30	15	47
195495	VTT.50-SST-p-M10x40-MD	50	M10	30	19	40	15	52

Adjustable handles

Metal Detectable technopolymer, stainless steel clamping element

LEVER BODY

Glass-fibre reinforced polyamide based (PA) technopolymer, RAL 5001 blue colour, matte finish. Produced from FDA compliant raw material (FDA CFR.21 and EU 10/2011).

The special technopolymer contains additives detectable by means of metal detectors. Built-in zinc alloy toothed insert for coupling to the metal clamping element.

STANDARD EXECUTIONS

- **ERZ-SST-MD**: AISI 303 stainless steel clamping element with threaded hole and retaining screw. AISI 302 stainless steel return spring.
 - **ERZ-SST-p-MD**: AISI 303 stainless steel clamping element with threaded stud and retaining screw. AISI 302 stainless steel return spring.
- Retaining screw with six-lobed socket to fit TORX®.

FEATURES AND APPLICATIONS

The RAL 5001 blue colour is easily visible in case of accidental food contamination. Furthermore the material additives are metal detectable at a cubic particle size of 5mm per side.

In order to improve the detection, the metal detector calibration must take into account the food/substance type at risk of contamination considering the moisture contained in it.

Particularly suitable for applications in the food and pharmaceutical industries. Particularly suitable when the lever turning angle is limited owing to lack of space. The metal teeth of the built-in zinc alloy insert allow the assembly of clamping elements completely made out of metal, which can be easily modified by machining in case of special assembly requirements.

INSTRUCTIONS OF USE

For clamping, lift the lever to disengage the clamping device teeth and bring it back to start position. By releasing the lever, the return spring automatically engages the teeth.

If the lever cannot make a 360° rotation, the clamping element can be easily screwed by means of the six-lobed socket front head screw (after having disengaged the lever).

* Registered trademark by **TEXTRON INC.**



ERGOSTYLE®

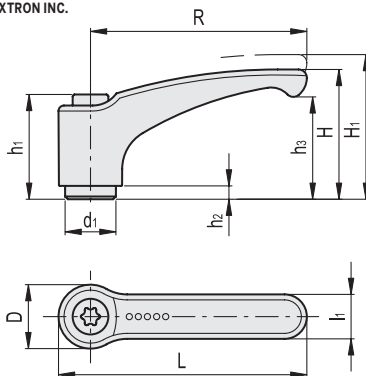

ERZ-SST-MD

ERZ-SST-p-MD

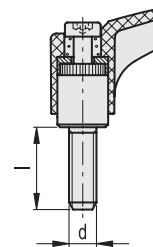
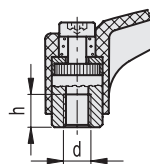

ERZ-SST-MD

STAINLESS STEEL

Code	Description	R	d	L	D	H	H1	h	h1	h2	h3	d1	l1	Teeth no.	⚖️
198135	ERZ.63 SST-M6-MD	63	M6	73.5	19	38.5	42	10	31	3.5	30	13.5	13.5	24	36
198155	ERZ.78 SST-M8-MD	78	M8	90.5	23	45	50.5	14	36	3.5	35	16	16	26	61

ERZ-SST-p-MD

STAINLESS STEEL

Code	Description	R	d	L	D	H	H1	h1	h2	h3	d1	l	l1	Teeth no.	⚖️
198429	ERZ.63 SST-p-M6x16-MD	63	M6	73.5	19	38.5	42	31	3.5	30	13.5	16	13.5	24	40
198433	ERZ.63 SST-p-M6x25-MD	63	M6	73.5	19	38.5	42	31	3.5	30	13.5	25	13.5	24	42
198673	ERZ.78 SST-p-M8x20-MD	78	M8	90.5	23	45	50.5	36	3.5	35	16	20	16	26	69
198679	ERZ.78 SST-p-M8x40-MD	78	M8	90.5	23	45	50.5	36	3.5	35	16	40	16	26	80

Bridge handles

Metal Detectable technopolymer

MATERIAL

Glass-fibre reinforced polyamide based (PA) technopolymer, RAL 5001 blue colour, matte finish.

Produced from FDA compliant raw material (FDA CFR.21 and EU 10/2011). The special technopolymer contains additives detectable by means of metal detectors.

STANDARD EXECUTION

AISI 303 stainless steel bosses, threaded holes.

FEATURES AND APPLICATIONS

The RAL 5001 blue colour is easily visible in case of accidental food contamination. Furthermore the material additives are metal detectable at a cubic particle size of 5mm per side.

In order to improve the detection, the metal detector calibration must take into account the food/substance type at risk of contamination considering the moisture contained in it.

Particularly suitable for applications in the food and pharmaceutical industries.



ELESA Original design

TECHNICAL DATA

Tensile stress and impact strength: F1, F2, L1 and L2 values reported in the table are the result of breaking tests carried out with the appropriate dynamometric equipment under the test conditions shown in the figure with ambient temperature.

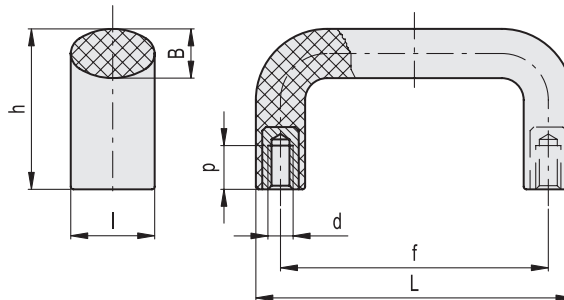
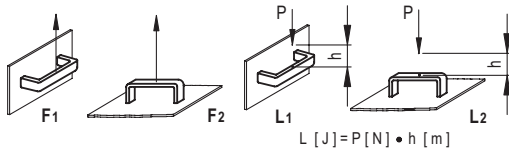

STAINLESS STEEL

Code	Description	L	f	d6H	h	B	l	p	F1 [N]	F2 [N]	L1 [J]	L2 [J]	⚖️
199113	M.643/140-117-SST-M8-MD	134	117±0.5	M8	49	15	25	13	2500	4500	8	12	67
199153	M.643/200-SST-M8-MD	196	179±1	M8	57	16	27	13	2000	3000	11	15	130

Knurled grip knobs

Metal Detectable technopolymer

MATERIAL

Glass-fibre reinforced polyamide based (PA) technopolymer, RAL 5001 blue colour, matte finish.

Produced from FDA compliant raw material (FDA CFR.21 and EU 10/2011). The special technopolymer contains additives detectable by means of metal detectors.

STANDARD EXECUTION

AISI 303 stainless steel boss, threaded blind hole.

FEATURES AND APPLICATIONS

The RAL 5001 blue colour is easily visible in case of accidental food contamination. Furthermore the material additives are metal detectable at a cubic particle size of 5mm per side.

In order to improve the detection, the metal detector calibration must take into account the food/substance type at risk of contamination considering the moisture contained in it.

Particularly suitable for applications in the food and pharmaceutical industries.

Cylindrical handle

Metal Detectable technopolymer

MATERIAL

Glass-fibre reinforced polyamide based (PA) technopolymer, RAL 5001 blue colour, matte finish.

Produced from FDA compliant raw material (FDA CFR.21 and EU 10/2011). The special technopolymer contains additives detectable by means of metal detectors.

MOUNTING

Threaded blind hole.

FEATURES AND APPLICATIONS

The RAL 5001 blue colour is easily visible in case of accidental food contamination. Furthermore the material additives are metal detectable at a cubic particle size of 5mm per side.

In order to improve the detection, the metal detector calibration must take into account the food/substance type at risk of contamination considering the moisture contained in it.

Particularly suitable for applications in the food and pharmaceutical industries.

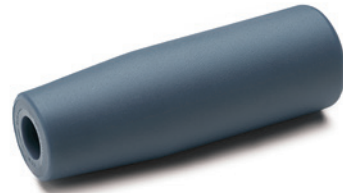

ELESA Original design

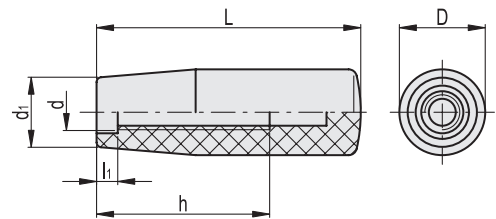
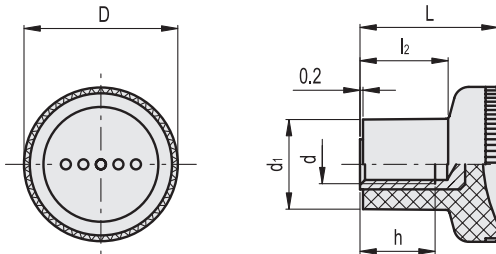

STAINLESS STEEL

Code	Description	D	L	d6H	d1	h	l2	Δ
199416	EKK.21-SST M5-MD	21	18	M5	12.5	10	10.5	7
199436	EKK.31-SST M8-MD	31	27	M8	18.5	15	17	20

Code	Description	D	L	d	d1	h	l1	Δ
199307	I.780/80-M10-MD	26.5	80	M10	21	55	7	45

Hinges

Metal Detectable technopolymer

MATERIAL

Glass-fibre reinforced polyamide based (PA) technopolymer, RAL 5001 blue colour, matte finish.

Produced from FDA compliant raw material (FDA CFR.21 and EU 10/2011). The special technopolymer contains additives detectable by means of metal detectors.

ROTATING PIN

AISI 303 stainless steel.

STANDARD EXECUTION

Pass-through holes for countersunk head screws.

FEATURES AND APPLICATIONS

The RAL 5001 blue colour is easily visible in case of accidental food contamination. Furthermore the material additives are metal detectable at a cubic particle size of 5mm per side.

In order to improve the detection, the metal detector calibration must take into account the food/substance type at risk of contamination considering the moisture contained in it.

Particularly suitable for applications in the food and pharmaceutical industries.



ROTATION ANGLE (APPROXIMATE VALUE)

Max 270° (-90° and +180° being 0° the condition where the two interconnected surfaces are on the same plane).

Do not exceed the rotation angle limit so as not to prejudice the hinge mechanical performance.

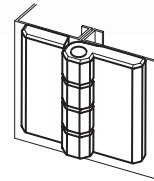
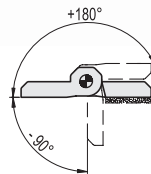
To choose the convenient type and the right number of hinges for your application, see the Guidelines.

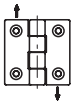

Resistance tests	AXIAL STRESS		RADIAL STRESS		90° ANGLED STRESS	
						
Description	Maximum working load Ea [N]	Load at breakage Ra [N]	Maximum working load Er [N]	Load at breakage Rr [N]	Maximum working load E90 [N]	Load at breakage R90 [N]
CFM.40 SH-5-MD	50	1100	100	1800	100	950
CFM.50 SH-6-MD	50	1900	100	3000	100	1200

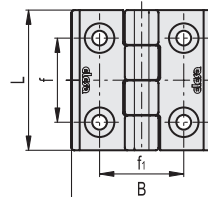
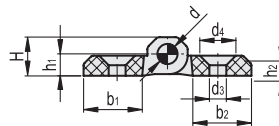

STAINLESS STEEL

Code	Description	L	B	f±0.25	f1±0.25	H	h1	h2	b1	b2	d	d3	d4	C# [Nm]	⚖
197511	CFM.40 SH-5-MD	40	40	25	25	9	5.5	5	14	14	4	5.5	10.5	2	14
197611	CFM.50 SH-6-MD	50	50	30	30	11.5	6.5	6	18	18	6	6.5	12.5	5	30

Suggested tightening torque for assembly screws.



Find out more on [elesa-ganter.com](https://www.elesa-ganter.com)

ELESA S.p.A.
Via Pompei 29
20900 Monza (MB)
Italy
+39 039 28 11 1
info@elesa.com
[elesa.com](https://www.elesa.com)

OTTO GANTER GmbH & Co. KG
Triberger Straße 3
78120 Furtwangen
Germany
+49 7723 65 07 0
info@ganternorm.com
[ganternorm.com](https://www.ganternorm.com)



DESIGNED
FOR ENGINEERING